

SCHEMA TECNICA

TORRETTE ELETTRICHE



CODICE PRODOTTO:
Sito: HO8005
Codice Me.Pa: HO8005

DESCRIZIONE:

Tre vie monofronte completo: n.6 prese tipo schuko.

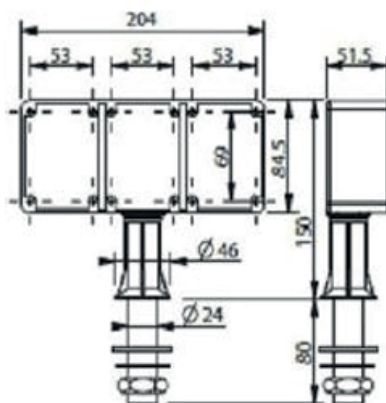

LINK PRODOTTO:

www.arrelab.it/product/torrette-elettriche-ho8005/

